

Catálogo

**MK**  
METAIS SANITÁRIOS E CONEXÕES





## Sobre nós

Há mais de 25 anos, a MK Metais segue atuando fortemente no mercado brasileiro. Com nossa sede principal localizada em Belo Horizonte, iniciamos nossa trajetória em 1996, produzindo conexões hidráulicas em latão direcionando o nosso foco inicial em Minas Gerais e de forma estratégica expandindo as operações de vendas para os demais estados brasileiros.

Hoje temos uma vasta linha de produtos, englobando além das já conhecidas conexões, outros itens como ca-valetes, metais para cozinha e banheiros, monocomando, acessórios e complementos para diversas aplicações do segmento.

Sempre prezamos pela qualidade dos nossos produtos e pelo fortalecimento das relações estabelecidas com os inúmeros parceiros, clientes, colaboradores e fornecedores.

Com muito esforço, trabalho e dedicação, características que já se tornaram referência do nosso trabalho, oferecemos um mix de produtos com preços competitivos e qualidade, que já se tornaram um importante diferencial dos nossos produtos no mercado!



# ÍNDICE

## **METAIS BANHEIRO**

MONOCOMANDOS BANHEIROS / SENSORIZADA.....	06
MONTE BELO C210.....	07
BELO HORIZONTE C37.....	08
ESCARPAS C36.....	10
SLIM C26.....	11
MK MATIC / DUCHAS ESPECIAIS.....	12
HOSPITALAR C98.....	13
BELVEDERE C65.....	14
PAMPULHA C29.....	15
MONTE VERDE C61.....	16
SAVASSI C35 / MONTES CLAROS C65-1.....	18
DIAMANTINA C34.....	19
ITAÚNA C31.....	21
MARIANA C50 / POMPÉU CC40.....	23
OURO PRETO C44 / OURO BRANCO C23.....	24

## **METAIS COZINHA / ÁREA DE SERVIÇO**

MONOCOMANDOS COZINHA.....	26
ESCARPAS C36.....	27
BELVEDERE C65.....	28
PAMPULHA C29.....	30
MONTE VERDE C61.....	32
SAVASSI C35 / MONTES CLAROS C65-1.....	35
DIAMANTINA C34.....	37
ITAÚNA C31.....	39
MARIANA C50 / POMPÉU CC40.....	41
OURO PRETO C44 / OURO BRANCO C23.....	43
GOURMET / MK CORES.....	45

## ACESSÓRIOS

CHUVEIROS.....	49
MONTE BELO C210 - ACESSÓRIOS.....	50
BELVEDERE C65 - ACESSÓRIOS.....	51
SAVASSI C35 - ACESSÓRIOS.....	54
MAX C10 / MASTER C20 / PRATELEIRAS - ACESSÓRIOS.....	55
KITS - ACESSÓRIOS.....	56
USO GERAL / ESFERA.....	57
LIGAÇÕES FLEXÍVEIS E FIXAÇÕES / SIFÕES.....	58
TUBOS DE LIGAÇÃO / BARRAS DE APOIO / VÁLVULAS.....	59
GRELHAS / RALOS / BASES E REGISTROS.....	61
COMPLEMENTOS.....	62
COMPONENTES.....	63
CONEXÕES CR.....	67
CONEXÕES LT.....	68
CAVALETES / HIDRÔMETRO.....	70

## Legenda



### CONSULTE AS DIMENSÕES DOS PRODUTOS



MISTURADOR MONOCOMANDO



PRODUTO COM SISTEMA DE VEDAÇÃO EM ESFERA



PRODUTO COM AREJADOR, ECONOMIA DE ÁGUA ATÉ 30%.



PRODUTO COM FECHAMENTO AUTOMÁTICO TEMPORIZADO.



PRODUTO COM BICA MÓVEL ARTICULÁVEL, ROTAÇÃO 360°.



PRODUTO COM CICLO DE ACIONAMENTO EM 1/4 DE VOLTA.



PRODUTO COM MECANISMO DE VEDAÇÃO SUBSTITUÍVEL REFORÇADO

*Metals Banheiro*





# Monocomandos Banheiro



**ATENÇÃO:** RECOMENDA-SE UMA PRESSÃO A PARTIR DE 5 METROS DE COLUNA DE ÁGUA ( M. C. A.) OU PRESSURIZADOR PARA TODOS OS MONOCOMANDOS.



**1320 CR** - Mist. Monocomando Bica Média  
1/2x1/2" Lavat. Mesa Vidro Verde



**1325 CR** - Mist. Monocomando Bica Baixa  
1/2x1/2" Lavat. Mesa Vidro Verde



**1330 CR** - Mist. Monocomando  
1/2x1/2" Quadrado Bica Fixa Alta



**1330 PT** - Mist. Monocomando  
1/2x1/2" Quadrado Bica Fixa Alta



**1335 CR** - Mist. Monocomando  
1/2x1/2" Quadrado Bica Fixa Média



**1335 PT** - Mist. Monocomando  
1/2x1/2" Quadrado Bica Fixa Média



## Sensorizada

Bivolt e com bateria reserva em  
em caso de falta de energia



**1140 CR** - Torneira Automática Sensorizada  
1/2" Lavatoria Mesa Bica Média





## Monte Belo - C210

Metals Banheiro



1195 C210 - Torneira Lav. Mesa  
1/2" Bica Média Retangular | 360°



1195 P210 - Torneira Lav. Mesa  
1/2" Bica Média Retangular | 360°



1195 RS210 - Torneira Lav. Mesa  
1/2" Bica Média Retangular | 360°



1199 C210 - Torneira Lav. Parede  
1/2" Bica Retangular | 360°



1199 P210 - Torneira Lav. Parede  
1/2" Bica Retangular | 360°

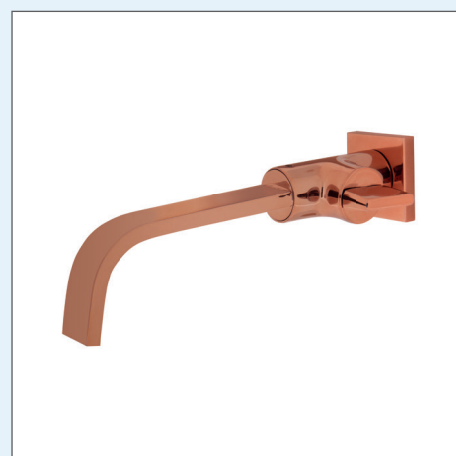

1199 RS210 - Torneira Lav. Parede  
1/2" Bica Retangular | 360°

Os produtos da Linha Monte Belo trazem em seu design o minimalismo das formas geométricas, composta por traços retangulares, redondos e quadrados unidos em perfeita harmonia. Essa composição resulta em uma linha de produtos que traz beleza e suavidade a qualquer ambiente.



1195 C37 - Torneira Lavatório  
1/2" Mesa Bica Média



1195 P37 - Torneira Lavatório  
1/2" Mesa Bica Média

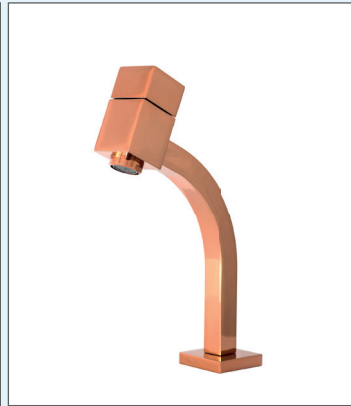

1195 RS37 - Torneira Lav.  
1/2" Mesa Bica Média



1208 C37 - Torneira Lavatório  
1/2" Mesa Bica Alta 45°



1208 P37 - Torneira Lavatório  
1/2" Mesa Bica Alta 45°



1208 RS37 - Torneira Lavatório  
1/2" Mesa Bica Alta 45°



1739 C37 - Ducha Hig. Quad.  
1/2" Gat. Metal Flex. 1,20m



1739 P37 - Ducha Hig. Quad.  
1/2" Gat. Metal Flex. 1,20m



1739 RS37 - Ducha Hig. Quad.  
1/2" Gat. Metal Flex. 1,20m



1209 C37 - Torneira Lavatório  
1/2" Mesa Bica Alta 90°



1209 P37 - Torneira Lavatório  
1/2" Mesa Bica Alta 90°







# Belo Horizonte - C37

Metals Banheiro



1209 P37 - Torneira Lavatório  
1/2" Mesa Bica Alta 90° 



1877 C37 - Torn. Lavatório Mesa  
1/2" Bica Alta Retangular

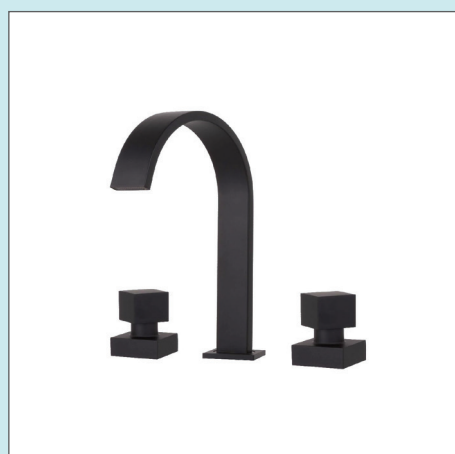

1877 P37 - Torn. Lavatório Mesa  
1/2" Bica Alta Retangular



1877 RS37 - Torn. Lavatório Mesa  
1/2" Bica Alta Retangular



1195B C37 - Torneira Lav. Mesa Bica  
1/2" Média Quad. Curvada



1195B P37 - Torneira Lav. Mesa Bica  
1/2" Média Quad. Curvada



1195B RS37 - Torneira Lav.  
1/2" Mesa Bica Média Quad. Curvada



509 C37 3/4" - Acabamento  
(1/2 - 3/4 - 1") Quadrado P/  
Reg. Pressão e Gaveta

509 C37 1.1/2" - Acabamento  
(1.1/4 - 1.1/2") Quadrado P/  
Registro de Gaveta



509 P37 3/4" - Acabamento  
(1/2 - 3/4 - 1") Quadrado P/  
Reg. Pressão e Gaveta

509 P37 1.1/2" - Acabamento  
(1.1/4 - 1.1/2") Quadrado P/  
Registro de Gaveta



509 RS37 3/4" - Acabamento  
(1/2 - 3/4 - 1") Quadrado P/  
Reg. Pressão e Gaveta

509 RS37 1.1/2" - Acabamento  
(1.1/4 - 1.1/2") Quadrado P/  
Registro de Gaveta

# Escarpas - C36



Metals Banheiro



1209 C36 - Torneira Lavatório  
1/2" Mesa Bica Alta 90°



1209 P36 - Torneira Lavatório  
1/2" Mesa Bica Alta 90°



1195 C36 - Torneira Lavatório  
1/2" Mesa Bica Média 24cm



1195 P36 - Torneira Lavatório  
1/2" Mesa Bica Média 24cm



1208 C36 - Torneira Lavatório  
1/2" Mesa Bica Alta 45°



1208 P36 - Torneira Lavatório  
1/2" Mesa Bica Alta 45°



1206 C36 - Torneira Lav. Mesa  
1/2" Bica Média 45° / 31cm



1150 C36 - Torneira Curta  
1/2" Lavatório Parede



1199 C36 - Torneira Longa  
1/2" Lavatório Parede



## Slim - C26

Metals Banheiro



1195 C26 - Torneira Lav. Mesa  
1/2" Bica Média Tubo Slim



1195 P26 - Torneira Lav. Mesa  
1/2" Bica Média Tubo Slim



1208 C26 - Torn. Lav. Mesa Bica  
1/2" Alta 45° Tubo Slim



1208 P26 - Torn. Lav. Mesa Bica  
1/2" Alta 45° Tubo Slim



1209 C26 - Torn. Lav. Mesa Bica  
1/2" Alta 90° Tubo Slim



1209 C26 - Torn. Lav. Mesa Bica  
1/2" Alta 90° Tubo Slim





## MK Matic



1161 CR - Torn. Automática Alta  
1/2" Lavatório Mesa



1160 CR - Torneira Automática  
1/2" Baixa Lavatório Mesa

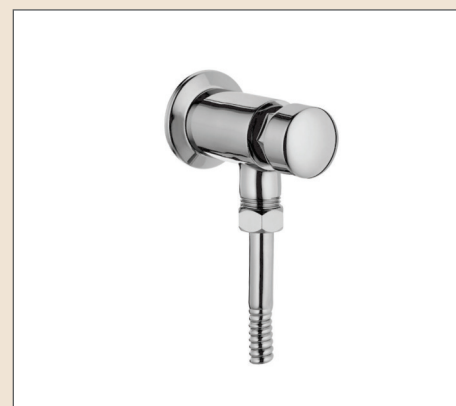

2570 CR - Válvula Automática  
1/2" p/ Mictório Parede



A Linha MK Matic possui um design totalmente funcional com o seu fechamento automático temporizado, liberando apenas a quantidade necessária de água para cada uso. Desenvolvida com acabamento em metal cromado, oferece maior durabilidade e resistência no uso, além de colaborar na redução do consumo de água.

## Duchas Especiais

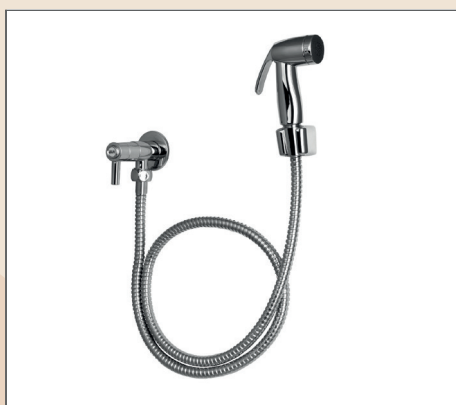

2740 C87 - Ducha Higiênica em ABS  
1/2" Flex. 1,20m



1740 C85 - Ducha Higiênica Com Suporte no Volante e Flex. 1,20m  
1/2"

Novidade:

Volante Com Dupla Função,  
Serve Também Como Suporte!

Fechamento Indutivo!



## Hospitalar - C98

Metals Banheiro



1195A C98 - Torneira Mesa  
1/2" Bica Fixa Média



1209 C98 - Torneira Mesa  
1/2" Bica Fixa Alta 90°



1208 C98 - Torneira Mesa  
1/2" Bica Fixa Alta 45°



1199 C98 - Torneira Longa  
1/2" Parede



1195B C98 - Torneira Mesa  
1/2" Bica Articulável



1165 C98 - Torneira Mesa Bica  
1/2" Arejador Articuláveis



1168 C98 - Torneira Parede Bica  
1/2" e Arejador Articuláveis



11591 C98 - Torneira Parede  
1/2" Com Arejador 22cm



1194 C98 - Torneira Mesa  
1/2" Baixa

# Belvedere - C65



Metals Banheiro



1877 C65 - Misturador 1/2" Lavatório Mesa | 360°



1195 C65 - Torneira 1/2" Lavatório Mesa | 360°



1740 C65 - Ducha Higiênica 1/2" Gat. Abs - Flex. 1,20m



1416 C65 - Registro de 1/2 ou 3/4" Pressão MVS |



1417 C65 - Registro de Pressão 1/2 ou 3/4" 1/4 De Volta |



1509 C65 - Registro de Gaveta

Bitolas Disponíveis				
1/2"	3/4"	1"	1.1/4"	1.1/2"



509 C65 3/4" - Acab. p/ Reg. de (1/2 - 1/3 - 1") Pressão e Gaveta  
509 C65 1.1/2" - Acabamento p/ (1.1/4 - 1.1/2") Reg. de Gaveta



OBS.: ACABAMENTOS SÃO APENAS COMPLEMENTOS DE LINHA SENDO ASSIM, NÃO POSSUEM MECANISMO DE VEDAÇÃO!





# Pampulha - C29

Metals Banheiro



1877 C29 - Misturador  
1/2" Lavatório Mesa | 360°



1195 C29 - Torneira  
1/2" Lavatório Mesa | 360°



1740 C29 - Ducha Higiênica  
1/2" Gat. Abs - Flex. 1,20m



1416 C29 - Registro de  
1/2 ou 3/4" Pressão MVS |



1417 C29 - Registro de Pressão  
1/2 ou 3/4" 1/4 De Volta |



1509 C29 - Registro de Gaveta

Bitolas Disponíveis				
1/2"	3/4"	1"	1.1/4"	1.1/2"



509 C29 3/4" - Acab. p/ Reg. de  
(1/2 - 3/4 - 1") Pressão e Gaveta  
509 C29 1.1/2" - Acabamento p/  
(1.1/4 - 1.1/2") Reg. de Gaveta

OBS.: ACABAMENTOS SÃO APENAS COMPLEMENTOS DE LINHA SENDO ASSIM, NÃO POSSUEM MECANISMO DE VEDAÇÃO!

# Monte Verde - C61

VOLANTE EM ABS



Metals Banheiro

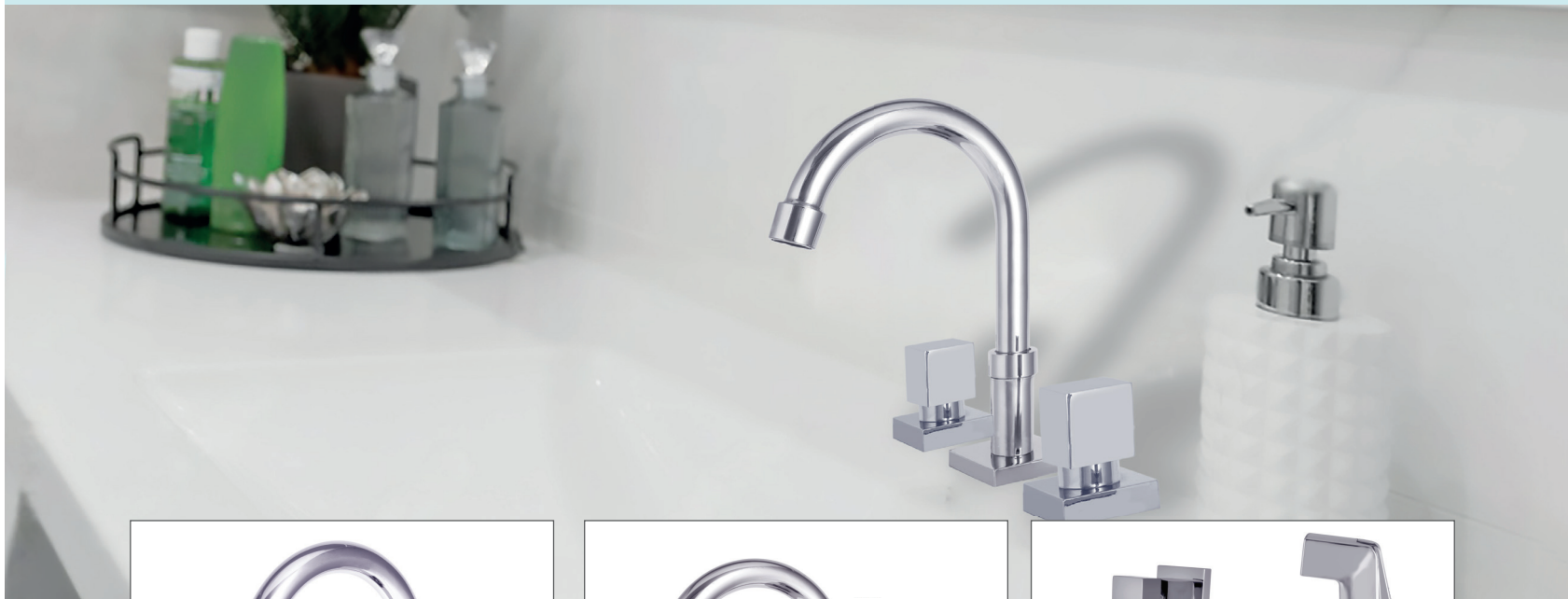

1195 C61 - Torneira  
1/2" Lavatório Mesa



1877 C61 - Misturador  
1/2" Lavatório Mesa



1740 C61 - Ducha Higiênica  
1/2" Gat/ Abs - Flex. 1,20m



1509 C61 - Registro Gaveta  
Com Acabamento

Bitolas Disponíveis				
1/2"	3/4"	1"	1.1/4"	1.1/2"



1416 C61 - Reg. Pressão mvs  
1/2 ou 3/4" c/ Acabamento

1417 C61 - Reg. Pressão 1/4 De  
1/2 ou 3/4" Volta c/ Acabamento



509 C61 3/4" - Acab. p/ Reg. Pressão  
(1/2 - 3/4 - 1") e Gaveta c/ Canopla Abs

509 C61 1.1/2"- Acab. p/ Reg. Gaveta c/  
(1.1/4 - 1.1/2") Canopla ABS





*"Design que combina com o seu estilo..."*





OPÇÕES DE ACABAMENTO:  
Montes Claros C65-1 



1195 C35 - Torneira  
1/2" Lavatório Mesa  



1194 C35 - Torneira Baixa  
1/2" Lavatório Mesa 



1740 C35 - Ducha Higiênica  
1/2" Gat.Abs - Flex. 1,20m



1877 C35 - Misturador  
1/2" Lavatório Mesa  



509 C35 1.1/2" - Acabamento p/  
(1.1/4 - 1.1/2") Reg. de Gaveta



509 C35 3/4" - Acab. p/ Reg. de  
(1/2 - 3/4 1") Pressão e Gaveta



1416 C35 - Registro de  
1/2 ou 3/4" Pressão MVS 



1417 C35 - Registro de Pressão  
1/2 ou 3/4" 1/4 De Volta 





1509 C35 - Registro de Gaveta



Bitolas Disponíveis				
1/2"	3/4"	1"	1.1/4"	1.1/2"





11951 C34 - Torn. Lavatório  
1/2" Mesa c/ Tubo 3/4"  



1195 C34 - Torneira  
1/2" Lavatório Mesa  



1740 C34 - Ducha Higiênica  
1/2" Gat/ Abs - Flex. 1,20m

1739 C34 - Ducha Higiênica  
1/2" Gat/ Metal - Flex. 1,20m



1877 C34 - Misturador  
1/2" Lavatório Mesa  



1194 C34 - Torneira Baixa  
1/2" Lavatório Mesa 





509 C34 1.1/2" - Acabamento p/ (1.1/4 - 1.1/2") Reg. de Gaveta



509 C34 3/4" - Acab. p/ Reg. de (1/2 - 3/4 - 1") Pressão e Gaveta



1416 C34 - Registro de 1/2 ou 3/4" Pressão MVS



1509 C34 - Registro de Gaveta

Bitolas Disponíveis				
1/2"	3/4"	1"	1.1/4"	1.1/2"



1417 C34 - Registro de Pressão 1/2 ou 3/4" 1/4 De Volta



OBS.: ACABAMENTOS SÃO APENAS COMPLEMENTOS DE LINHA SENDO ASSIM, NÃO POSSUEM MECANISMO DE VEDAÇÃO!









## Itaúna - C31

Metais Banheiro



11951 C31 - Torn. Lavatório  
1/2" Mesa c/ Tubo 3/4"  



1195 C31 - Torneira  
1/2" Lavatório Mesa  



1877 C31 - Misturador  
1/2" Lavatório Mesa  



1194 C31 - Torneira Baixa  
1/2" Lavatório Mesa 



1739 C31 - Ducha Higiênica  
1/2" Gat/ Metal - Flex. 1,20m

1740 C31 - Ducha Higiênica  
1/2" Gat/ Abs - Flex. 1,20m

A Linha Itaúna C31 traz os traços de uma linha clássica, com design simples e funcional. Seu acionamento em 1/4 de volta e volante em forma de cruzeta, permite uma excelente ergonomia e experiência de uso, combinando perfeitamente com os mais diversos ambientes.



509 C31 1.1/2" - Acabamento p/ (1.1/4 - 1.1/2") Reg. de Gaveta



509 C31 3/4" - Acab. p/ Reg. de (1/2 - 3/4 - 1") Pressão e Gaveta



1416 C31 - Registro de 1/2 ou 3/4" Pressão MVS



1417 C31 - Registro de Pressão 1/2 ou 3/4" 1/4 De Volta



1509 C31 - Registro de Gaveta

Bitolas Disponíveis				
1/2"	3/4"	1"	1.1/4"	1.1/2"



OBS.: ACABAMENTOS SÃO APENAS COMPLEMENTOS DE LINHA SENDO ASSIM, NÃO POSSUEM MECANISMO DE VEDAÇÃO!





MVS+

# Mariana - C50



Metals Banheiro

OPÇÕES DE ACABAMENTO:  
Pompéu CC40



11951 C50 - Torn. Lavatório  
1/2" Mesa c/ Tubo 3/4"  



1195 C50 - Torneira  
1/2" Lavatório Mesa  



1877 C50 - Misturador  
1/2" Lavatório Mesa  



1194 C50 - Torneira Baixa  
1/2" Lavatório Mesa 



1739 C50 - Ducha Higiênica  
1/2" Gat/ Metal - Flex. 1,20m



1740 C50 - Ducha Higiênica  
1/2" Gat/ Abs - Flex. 1,20m



509 C50 1.1/2" - Acabamento p/  
(1.1/4 - 1.1/2") Reg. de Gaveta



509 C50 3/4" - Acab. p/ Reg. de  
(1/2 - 3/4 - 1") Pressão e Gaveta



1416 C50 - Registro de  
1/2 ou 3/4" Pressão MVS 



1509 C50 - Registro  
de Gaveta

Bitolas Disponíveis

1/2"	3/4"	1"	1.1/4"	1.1/2"
------	------	----	--------	--------

OBS.: ACABAMENTOS SÃO APENAS COMPLEMENTOS DE LINHA SENDO ASSIM, NÃO POSSUEM MECANISMO DE VEDAÇÃO!

# Ouro Preto - C44

MVS+



OPÇÕES DE ACABAMENTO:  
Ouro Branco C23



Metais Banheiro



1195 C44 - Torneira  
1/2" Lavatório Mesa



1193 C44 - Torneira Baixa  
1/2" Lavatório Mesa



1739 C44 - Ducha Higiénica  
1/2" Gat/ Metal - Flex. 1,20m



509 C44 1.1/2" - Acabamento p/  
(1.1/4 - 1.1/2") Reg. de Gaveta



509 C44 3/4" - Acab. p/ Reg. de  
(1/2 - 3/4 - 1") Pressão e Gaveta



1509 C44 - Registro de Gaveta

Bitolas Disponíveis				
1/2"	3/4"	1"	1.1/4"	1.1/2"



1416 C44 - Registro de  
1/2 ou 3/4" Pressão MVS

MVS+

OBS.: ACABAMENTOS SÃO APENAS COMPLEMENTOS DE LINHA SENDO ASSIM, NÃO POSSUEM MECANISMO DE VEDAÇÃO!



*Metais De Cozinha / Área De Serviço*



# Monocomandos Cozinha



Metais Cozinha

**ATENÇÃO:** RECOMENDA-SE UMA PRESSÃO A PARTIR DE 5 METROS DE COLUNA DE ÁGUA ( M. C. A.) OU PRESSURIZADOR PARA TODOS OS MONOCOMANDOS.



**1305 CR / PT** - Misturador Monocomando Bica  
1/2x1/2" Móvel Média Gourmet Mesa - 52cm



**1300 CR / PT** - Misturador Monocomando Bica  
1/2x1/2" Móvel Alta Gourmet Mesa - 70cm



**1360 PT** - Misturador Monocomando Tubo  
1/2x1/2" Articulado Slim Cozinha Mesa



**1310 CR** - Misturador Monocomando  
1/2x1/2" Gourmet Mesa - 50cm



**1310 PT** - Misturador Monocomando  
1/2x1/2" Gourmet Mesa - 50cm



**1195 C85** - Misturador Monocomando  
1/2x1/2" Bica Alta Mesa - 30cm



**1195 P85** - Misturador Monocomando  
1/2x1/2" Bica Alta Mesa - 30cm







1/4  
de Volta

## Escarpas - C36



Metals Cozinha



1166 C36 - Torneira Alta  
1/2" Cozinha Mesa 45°



1210 C36 - Torneira Alta  
1/2" Cozinha Mesa 90°

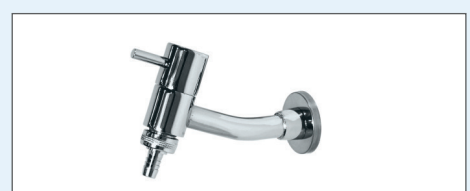

1149 C36 - Torneira Curta p.  
1/2 ou 3/4" Tanque ou Jardim



1157 C36 - Torneira Longa  
1/2" Tanque ou Jardim





# Belvedere - C65





Metals Cozinha / Área de Serviço



1165 C65 - Torneira  
1/2" Cozinha Mesa  



1168 C65 - Torneira  
1/2" Cozinha Parede  



11591 C65 - Torneira Coz. Parede  
1/2" com Arejador 22cm 



11592 C65 - Torneira Cozinha  
1/2 x 3/4" c/ Bico - 22cm



1126 C65 - Torneira Jardim  
3/4" c/ Arejador 



1130 C65 - Torneira Jardim  
3/4 x 3/4" c/ Bico



1132 C65 - Torneira c/ Saída p/  
1/2 x 3/4 x 3/4" Máquina de Lavar

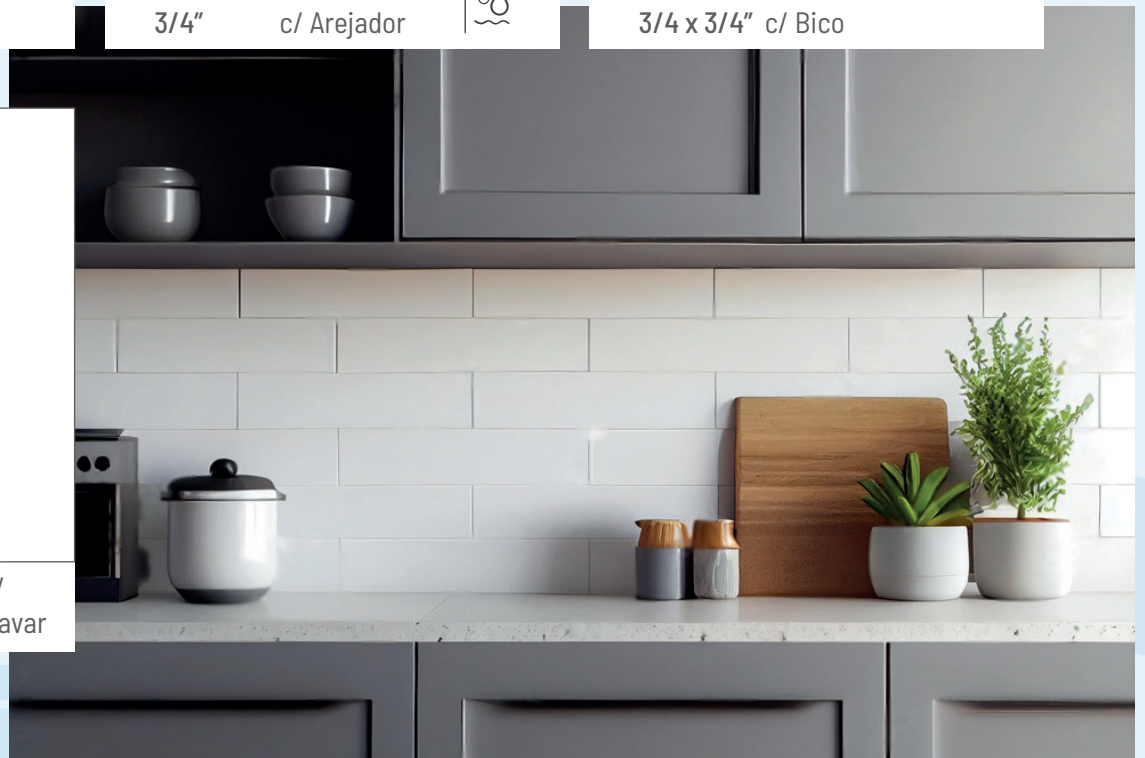



# Belvedere - C65

Metals Cozinha



cores  
C65 P65 V65  
● ● ●

1187 - Torneira Coz.  
1/2" Mesa Tubo  
Gourmet Cônico



cores  
C65 P65 V65  
● ● ●

1190 - Torneira Coz.  
1/2" Parede Tubo  
Gourmet Cônico



cores  
P65 V65  
● ●

1164 - Torneira Coz.  
1/2" Mesa Tubo  
Gourmet Slim



cores  
P65 V65  
● ●

1171 - Torneira Coz.  
1/2" Parede Tubo  
Gourmet Slim



1167 C65 - Torneira Coz. Mesa  
1/2" Tubo Gourmet



1170 C65 - Torneira Coz. Parede  
1/2" Tubo Gourmet





# Pampulha - C29



Metals Cozinha / Área de Serviço



1165 C29 - Torneira  
1/2" Cozinha Mesa |



1168 C29 - Torneira  
1/2" Cozinha Parede |



11591 C29 - Torneira Cozinha  
1/2" Parede c/ Arejador 22cm |



11592 C29 - Torneira Cozinha  
1/2 x 3/4" c/ Bico - 22cm



1126 C29 - Torneira Jardim  
3/4" c/ Arejador |



1130 C29 - Torneira Jardim  
3/4 x 3/4" c/ Bico



1132 C29 - Torneira c/ Saida p/  
1/2 x 3/4 x 3/4" Máquina de Lavar



# Pampulha - C29

Metals Cozinha



cores  
C29 P29 V29  
● ● ●

1187 - Torneira Coz.  
1/2" Mesa Tubo  
Gourmet Cônico



cores  
C29 P29 V29  
● ● ●

1190 - Torneira Coz.  
1/2" Parede Tubo  
Gourmet Cônico



cores  
P29 V29  
● ●

1164 - Torneira Coz.  
1/2" Mesa Tubo  
Gourmet Slim



cores  
P29 V29  
● ●

1171 - Torneira Coz.  
1/2" Parede Tubo  
Gourmet Slim



1167 C29 - Torneira Coz. Mesa  
1/2" Tubo Gourmet



1170 C29 - Torneira Coz. Parede  
1/2" Tubo Gourmet





# Monte Verde - C61

VOLANTE EM ABS



Metals Cozinha / Área de Serviço



1165 C61 - Torneira Cozinha  
1/2" Mesa  



1168 C61 - Torneira Cozinha  
1/2" Parede  



11591 C61 - Torneira Cozinha  
1/2" Parede c/ Arejador - 22cm 



11592 C61 - Torneira Cozinha  
1/2x3/4" Parede c/ Bico 3/4" - 22cm



1132 C61 - Torneira c/ Saída  
1/2x3/4x3/4" p/ Máquina de Lavar



1130 C61 - Torneira Jardim  
3/4x3/4" c/ Bico



1126 C61 - Torneira Jardim  
3/4" c/ Arejador 







# Monte Verde - C61

VOLANTE EM ABS

Metais Cozinha



cores
C61 P61 V61
● ● ●

1187 - Torneira Coz.  
1/2" Mesa Tubo  
Gourmet Cônico



cores
C61 P61 V29
● ● ●

1190 - Torneira Coz.  
1/2" Parede Tubo  
Gourmet Cônico



cores
P61 V61
● ●

1164 - Torneira Coz.  
1/2" Mesa Tubo  
Gourmet Slim



cores
P61 V61
● ●

1171 - Torneira Coz.  
1/2" Parede Tubo  
Gourmet Slim



1167 C61 - Torneira Coz. Mesa  
1/2" Tubo Gourmet



1170 C61 - Torneira Coz. Parede  
1/2" Tubo Gourmet



*"Elegância em qualquer ambiente..."*







# Savassi - C35

Metais Cozinha

OPÇÕES DE ACABAMENTO:  
Montes Claros C65-1



1168 C35 - Torneira  
1/2" Coz. Parede  





1165 C35 - Torneira  
1/2" Cozinha Mesa  





1868 C35 - Torneira Coz. Parede  
1/2 x 1/4" c/ Saída p/ Filtro  



1865 C35 - Torneira Coz. Mesa  
1/2 x 1/4" c/ Saída p/ Filtro  





Produto Certificado

18650 C35 - Torneira Coz. Mesa  
1/2" Bica Móvel c/ Filtro  



Produto Certificado

18680 C35 - Torneira Coz. Parede  
1/2" Bica Móvel c/ Filtro  

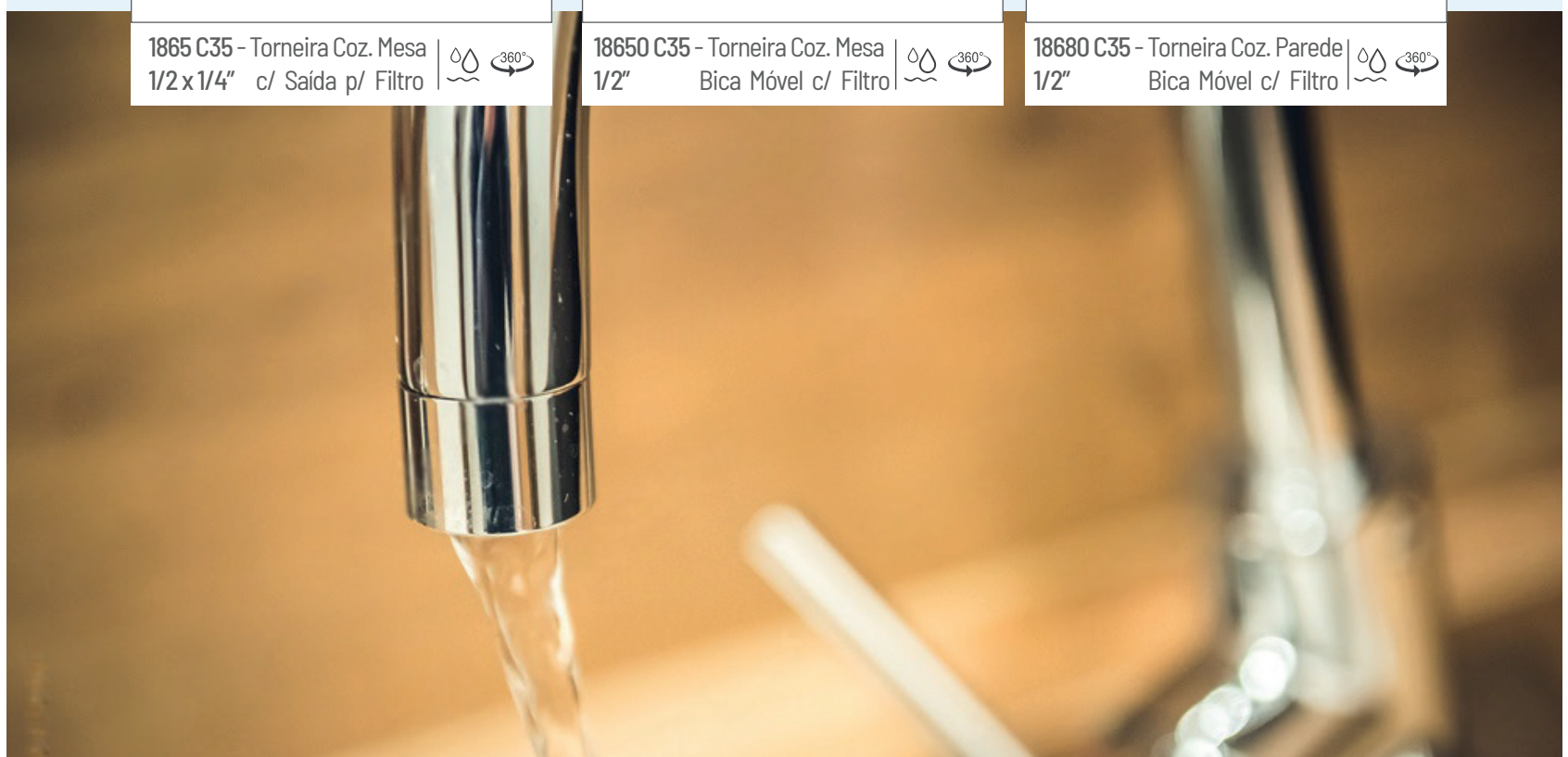



OPÇÕES DE ACABAMENTO:  
Montes Claros C65-1 





1256 C35 - Misturador Cozinha  
1/2 x 1/2" Mesa  



1258 C35 - Misturador Cozinha  
1/2 x 1/2" Parede  



1169 C35 - Torneira Cozinha  
1/2" Bica Baixa Parede  



18000 C35 - Torneira Cozinha  
1/2" Parede Reta c/ Filtro 

1800 C35 - Torneira Coz. Parede  
1/2x1/4" Reta c/ Saída p/ Filtro 



11581 C35 - Torneira Coz. Parede  
1/2" c/ Arejador - 18 cm 

11591 C35 - Torneira Coz. Parede  
1/2" c/ Arejador - 22 cm 



11582 C35 - Torneira Coz. Parede  
1/2x3/4" c/ Bico - 18 cm

11592 C35 - Torneira Coz. Parede  
1/2 x3/4" c/ Bico - 22 cm



1130 C35 - Torneira p/ Jardim  
1/2 x 1/2" c/ Bico

1130 C35 - Torneira p/ Jardim  
3/4 x 3/4" c/ Bico





1132 C35 - Torneira c/ Saída p/  
1/2 x 3/4 x 3/4" Máquina de Lavar





## Diamantina - C34

Metals Cozinha



11651 C34 - Torneira Cozinha  
1/2" Mesa c/ Tubo 3/4"  



11681 C34 - Torneira Cozinha  
1/2" Parede c/ Tubo 3/4"  







1165 C34 - Torneira Cozinha  
1/2" Mesa  





1168 C34 - Torneira Cozinha  
1/2" Parede  



1865 C34 - Torneira Coz. Mesa  
1/2 x 1/4" c/ Saída p/ Filtro  

18651 C34 - Torn. Coz. Mesa c/ Saída  
1/2 x 1/4" p/ Filtro e Tubo 3/4"  



1868 C34 - Tor. Cozinha Parede  
1/2 x 1/4" c/ Saída p/ Filtro  

18681 C34 - Tor. Cozinha Parede c/  
1/2 x 1/4" Saída p/ Filtro e Tubo 3/4"  



1256 C34 - Misturador Cozinha  
1/2 x 1/2" Mesa  



1258 C34 - Misturador Cozinha  
1/2 x 1/2" Parede  



# Diamantina - C34



Metals Cozinha / Área de Serviço

Produto Certificado



18000 C34 - Torneira Cozinha  
1/2" Parede Reta c/ Filtro

1800 C34 - Torneira Cozinha Parede  
1/2 x 1/4" Reta c/ Saída p/ Filtro

Produto Certificado



18650 C34 - Tor. Coz. Mesa  
1/2" Bica Móvel c/ Filtro

Produto Certificado



18680 C34 - Tor. Coz. Parede  
1/2" Bica Móvel c/ Filtro



11581 C34 - Torneira Cozinha Parede  
1/2" c/ Arejador - 18cm

11591 C34 - Torneira Cozinha Parede  
1/2" c/ Arejador - 22cm



11582 C34 - Torneira Cozinha Parede  
1/2 x 3/4" c/ Bico - 18cm

11592 C34 - Torneira Cozinha Parede  
1/2 x 3/4" c/ Bico - 22cm



1130 C34 - Torneira p/ Jardim  
1/2 x 1/2" c/ Bico

1130 C34 - Torneira p/ Jardim  
3/4 x 3/4" c/ Bico



1125 C34 - Torneira Curta  
1/2" p/ Bebedouro





1132 C34 - Torneira c/ Saída p/  
1/2 x 3/4 x 3/4" Máquina de Lavar





A Linha Itaúna C31 traz os traços de uma linha clássica, com design simples e funcional. Seu acionamento em 1/4 de volta e volante em forma de cruzeta, permite uma excelente ergonomia e experiência de uso, combinando perfeitamente com os mais diversos ambientes.



**11651 C31** - Torneira Cozinha  
1/2" Mesa c/ Tubo 3/4"  



**11681 C31** - Torneira Cozinha  
1/2" Parede c/ Tubo 3/4"  





**1165 C31** - Torneira Cozinha  
1/2" Mesa  





**1168 C31** - Torneira Cozinha  
1/2" Parede  

Produto Certificado





**18680 C31** - Tor. Coz. Parede  
1/2" Bica Móvel c/ Filtro  



**1865 C31** - Torneira Coz. Mesa  
1/2 x 1/4" c/ Saída p/ Filtro  



**1868 C31** - Tor. Cozinha Parede Bica  
1/2 x 1/4" Móvel c/ Saída p/ Filtro  

**18651 C31** - Torneira Coz. Mesa c/  
1/2 x 1/4" Saída p/ Filtro e Tubo 3/4"  

**18681 C31** - Tor. Cozinha Parede Bica Móvel  
1/2 x 1/4" c/ Saída p/ Filtro e Tubo 3/4"  



1256 C31 - Misturador Cozinha  
1/2x1/2" Mesa



1258 C31 - Misturador Cozinha  
1/2x1/2" Parede



Produto Certificado

18650 C31 - Tor. Coz. Mesa  
1/2x1/4" Bica Móvel c/ Filtro



Produto Certificado

18000 C31 - Torneira Cozinha  
1/2" Parede Reta c/ Filtro



1800 C31 - Torneira Cozinha Parede  
1/2x1/4" Reta c/ Saída p/ Filtro



11581 C31 - Torneira Cozinha Parede  
1/2" c/ Arejador - 18cm



11591 C31 - Torneira Cozinha Parede  
1/2" c/ Arejador - 22cm



11582 C31 - Torneira Cozinha Parede  
1/2x3/4" c/ Bico - 18cm

11592 C31 - Torneira Cozinha Parede  
1/2x3/4" c/ Bico - 22cm



1130 C31 - Torneira p/ Jardim  
1/2x1/2" c/ Bico

1130 C31 - Torneira p/ Jardim  
3/4x3/4" c/ Bico



1132 C31 - Torneira c/ Saída p/  
1/2x3/4x3/4" Máquina de Lavar

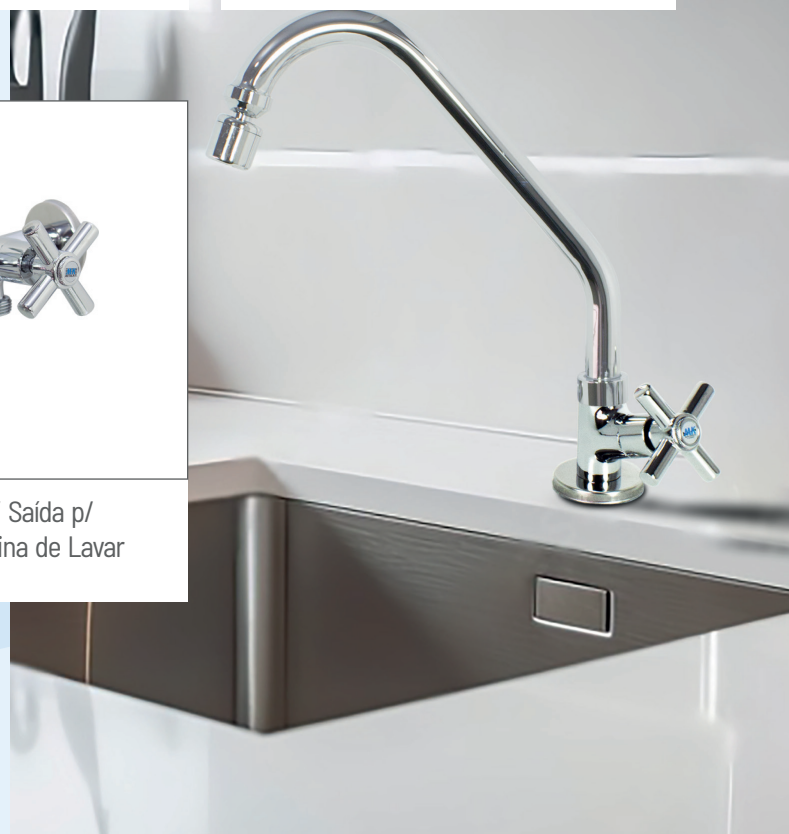





MVS+

# Mariana - C50



Metais Cozinha

OPÇÕES DE ACABAMENTO:  
Pompêu CC40





11651 C50 - Torneira Cozinha  
1/2" Mesa c/ Tubo 3/4"  



11681 C50 - Torneira Cozinha  
1/2" Parede c/ Tubo 3/4"  





1165 C50 - Torneira Cozinha  
1/2" Mesa  



1168 C50 - Torneira Cozinha  
1/2" Parede  





18680 C50 - Tor. Coz. Parede  
1/2" Bica Móvel c/ Filtro  



18650 C50 - Tor. Coz. Mesa  
1/2" Bica Móvel c/ Filtro  



1865 C50 - Torneira Coz. Mesa  
1/2 x 1/4" c/ Saída p/ Filtro  

18651 C50 - Torneira Coz. Mesa c/  
1/2 x 1/4" Saída p/ Filtro e Tubo 3/4"  



1868 C50 - Tor. Cozinha Parede Bica  
1/2 x 1/4" Móvel c/ Saída p/ Filtro  

18681 C50 - Tor. Cozinha Parede Bica Móvel  
1/2 x 1/4" c/ Saída p/ Filtro e Tubo 3/4"  





# Mariana - C50

MVS+



Metals Cozinha

OPÇÕES DE ACABAMENTO:  
Pompéu CC40

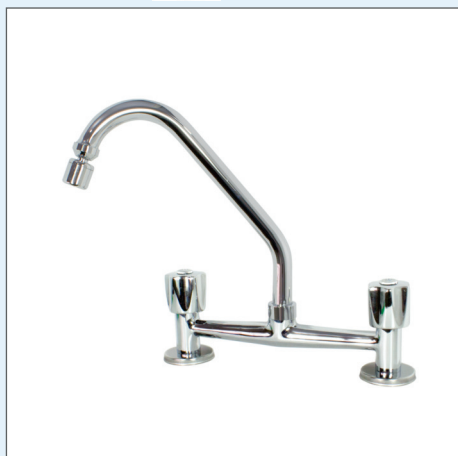

1256 C50 - Misturador Cozinha  
1/2 x 1/2" Mesa



1258 C50 - Misturador Cozinha  
1/2 x 1/2" Parede



Produto Certificado

18000 C50 - Torneira Cozinha  
1/2" Parede Reta c/ Filtro

1800 C50 - Torneira Coz. Parede  
1/2 x 1/4" Reta c/ Saída p/ Filtro



1158 C50 - Torneira Cozinha  
1/2" Parede - 18cm

1159 C50 - Torneira Cozinha  
1/2" Parede - 22cm



1132 C50 - Torneira c/ Saída p/  
1/2 x 3/4 x 3/4" Máquina de Lavar



11581 C50 - Torneira Cozinha Parede  
1/2" c/ Arejador - 18cm

11591 C50 - Torneira Cozinha Parede  
1/2" c/ Arejador - 22cm

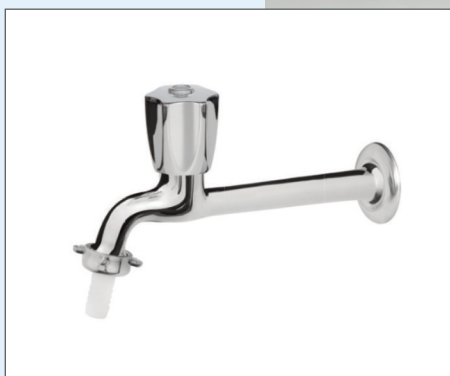

11582 C50 - Torneira Cozinha Parede  
1/2 x 3/4" c/ Bico - 18cm

11592 C50 - Torneira Cozinha Parede  
1/2 x 3/4" c/ Bico - 22cm



1130 C50 - Torneira p/ Jardim  
1/2 x 1/2" c/ Bico

1130 C50 - Torneira p/ Jardim  
3/4 x 3/4" c/ Bico





MVS+

## Ouro Preto - C44

Metals Cozinha / Área de Serviço

OPÇÕES DE ACABAMENTO:  
Ouro Branco C23



1165 C44 - Torneira Cozinha  
1/2" Mesa |  



1168 C44 - Torneira Cozinha  
1/2" Parede |  



1158 C44 - Torneira Cozinha  
1/2" Parede - 18cm



1159 C44 - Torneira Cozinha  
1/2" Parede - 22cm



11581 C44 - Torneira Cozinha Parede  
1/2" c/ Arejador - 18cm | 



11591 C44 - Torneira Cozinha Parede  
1/2" c/ Arejador - 22cm | 

# Ouro Preto - C44

MVS+



Metals Cozinha / Área de Serviço

OPÇÕES DE ACABAMENTO:

Ouro Branco C23



11582 C44 - Torneira Cozinha Parede  
1/2 x 3/4" c/ Bico - 18cm



11592 C44 - Torneira Cozinha Parede  
1/2 x 3/4" c/ Bico - 22cm



1132 C44 - Torneira c/ Saída p/  
1/2 x 3/4 x 3/4" Máquina de Lavar



1130 C44 - Torneira p/ Jardim  
3/4 x 3/4" c/ Bico



1130 C44 - Torneira p/ Jardim  
1/2 x 1/2" c/ Bico



1126 C44 - Torneira p/ Jardim  
1/2" s/ Bico



1125 C44 - Torneira Curta  
1/2" p/ Bebedouro



# Gourmet / MK Cores

Metals Cozinha



1187 | Torn. Cozinha Mesa  
1/2" | Tubo Gourmet Cônico

cores			acabamentos			360° W
CR	P	V	C65-1	C35	C34	
●	●	●				
			C31	C50	CC40	



1190 | Torn. Cozinha Parede  
1/2" | Tubo Gourmet Cônico

cores			acabamentos			360° W
CR	P	V	C65-1	C35	C34	
●	●	●				
			C31	C50	CC40	



1164 | Torn. Cozinha Mesa  
1/2" | Tubo Gourmet Slim

cores		acabamentos		360° W
P	V	C65-1	C35	
●	●			
		C34	C31	



1171 | Torn. Cozinha Parede  
1/2" | Tubo Gourmet Slim

cores		acabamentos		360° W
P	V	C65-1	C35	
●	●			
		C34	C31	







1170 CR | Torn. Cozinha Parede 1/2" | Tubo Gourmet

cores	acabamentos			
CR	C65-1	C35	C34	360° W
	C31	C50	CC40	



1167 CR | Torn. Cozinha Mesa 1/2" | Tubo Gourmet

cores	acabamentos			
CR	C65-1	C35	C34	360° W
	C31	C50	CC40	



Produto Certificado

18670 | Torn. Coz. Mesa c/ Filtro 1/2" | Tubo Gourmet Cônico

cores	acabamentos			
CR P V	C65-1	C31	C35	360° W
CR	C50	CC40		



Produto Certificado

18700 | Torn. Coz. Parede c/ Filtro 1/2" | Tubo Gourmet Cônico

cores	acabamentos			
CR P V	C65-1	C31	C35	360° W
CR	C50	CC40		



Produto Certificado

18640 | Torn. Coz. Mesa c/ Filtro 1/2" | Tubo Gourmet Slim

cores	acabamentos			
P V	C65-1	C31	C35	360° W
	C34			





Produto Certificado

**18710** | Torn. Coz. Parede c/ Filtro 1/2" | Tubo Gourmet Slim

cores		acabamentos				360° 👉 💧
P	V	C65-1	C31	C34	C35	



Produto Certificado

**18660 CR** | Torn. Coz. Mesa c/ Filtro 1/2" | Tubo Gourmet

cores		acabamentos				360° 👉 💧
CR		C65-1	C31	C34	C35	
		C50	CC40			



Produto Certificado

**18690 CR** | Torn. Coz. Parede c/ Filtro 1/2" | Tubo Gourmet

cores		acabamentos				360° 👉 💧
CR		C65-1	C31	C34	C35	
		C50	CC40			



**1250 CR** | Mist. Coz. Mesa 1/2" | Tubo Gourmet

**1260 CR** | Mist. Coz. Parede 1/2" | Tubo Gourmet

cores		acabamentos			
CR		C65-1	C31	C34	C35

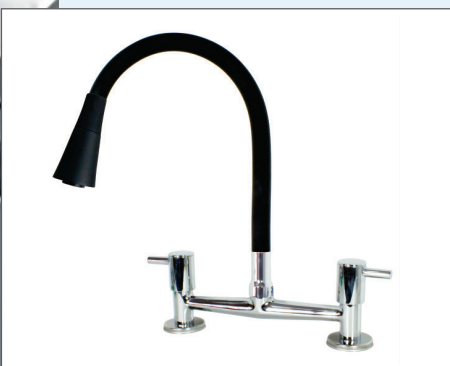

**1254** | Mist. Coz. Mesa 1/2" | Tubo Gourmet Cônico

**1257** | Mist. Coz. Parede 1/2" | Tubo Gourmet Cônico

cores		acabamentos				360° 👉 💧
CR	P V	C65-1	C31	C34	C35	
CR		C50	CC40			

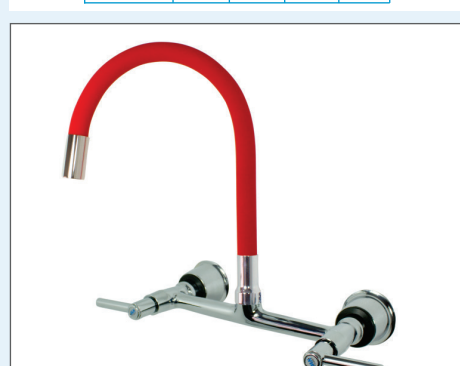

**1255** | Mist. Coz. Mesa 1/2" | Tubo Gourmet Slim

**1259** | Mist. Coz. Parede 1/2" | Tubo Gourmet Slim

cores		acabamentos			
P	V	C65-1	C31	C34	C35

*"Um verdadeiro banho de qualidade e sofisticação..."*







## Chuveiros



**3000 C65** - Chuv. Quadrado Articulável  
1/2" Metal Parede - Bojo 200mm

**3000 C29** - Chuv. Quadrado Articulável  
1/2" Metal Parede - Bojo 300mm



**3100 C65** - Chuv. Quadrado Articulável  
1/2" Metal Teto - Bojo 200mm

**3100 C29** - Chuv. Quadrado Articulável  
1/2" Metal Teto - Bojo 300mm



**3000 P65** - Chuv. Quadrado Articulável  
1/2" Metal Parede - Bojo 200mm



**3000 C31** - Chuv. Redondo Articulável  
1/2" Parede - Bojo 95mm

**3005 C31** - Chuv. Redondo Art. Parede c/ 05 Opções  
1/2" de Jatos Ajustáveis - Bojo 95mm



**3000 C35** - Chuv. Quadrado Articulável  
1/2" Parede - Bojo 200mm



**3000 C34** - Chuv. Quadrado Articulável  
1/2" Parede - Bojo 200mm



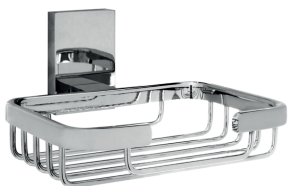

4110 C210 - Saboneteira Aramada Parede



4110 P210 - Saboneteira Aramada Parede



4300 C210 - Papeleira s/ Cobertura



4300 P210 - Papeleira s/ Cobertura



4400 C210 - Toalheiro Barra Simples 60cm

4410 C210 - Toalheiro Barra Simples 30cm



4400 P210 - Toalheiro Barra Simples 60cm

4410 P210 - Toalheiro Barra Simples 30cm



4600 C210 - Cabide Simples



4600 P210 - Cabide Simples



4700 C210 - Prateleira Vidro

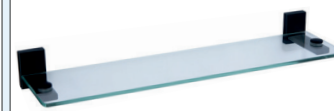

4700 P210 - Prateleira Vidro



4100 C65 - Saboneteira Parede



4100 P65 - Saboneteira Parede

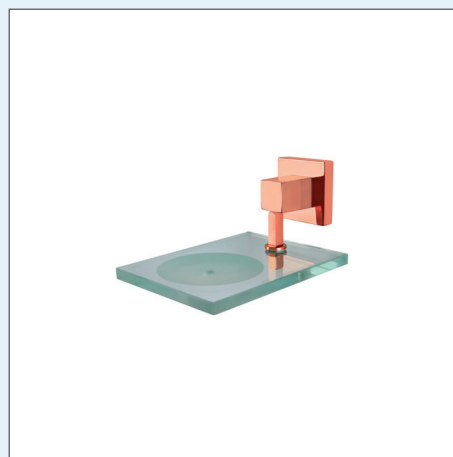

4100 RS65 - Saboneteira Parede



4300 C65 - Papeleira s/ Cobertura

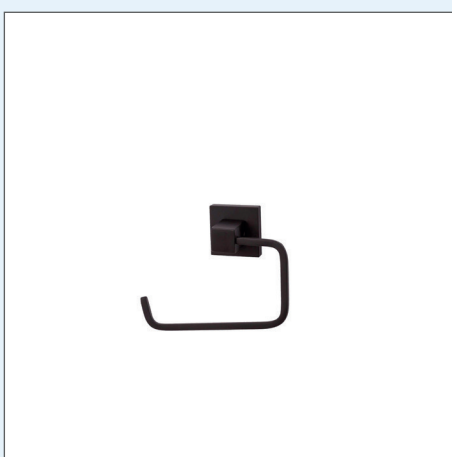

4300 P65 - Papeleira s/ Cobertura

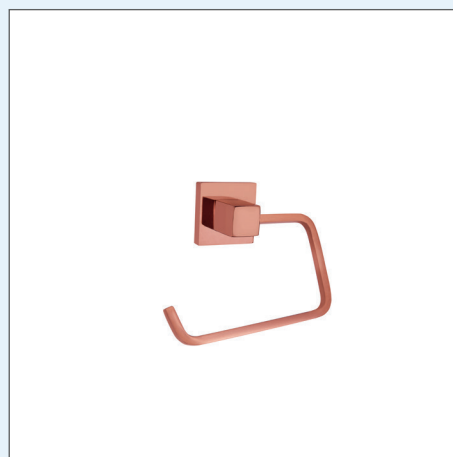

4300 RS65 - Papeleira s/ Cobertura



4600 C65 - Cabide Simples



4600 P65 - Cabide Simples

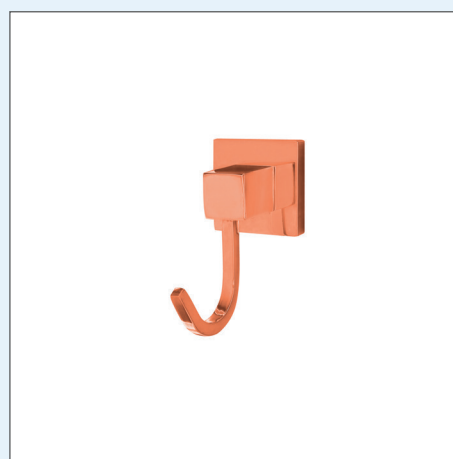

4600 RS65 - Cabide Simples



4500 C65 - Toalheiro Argola

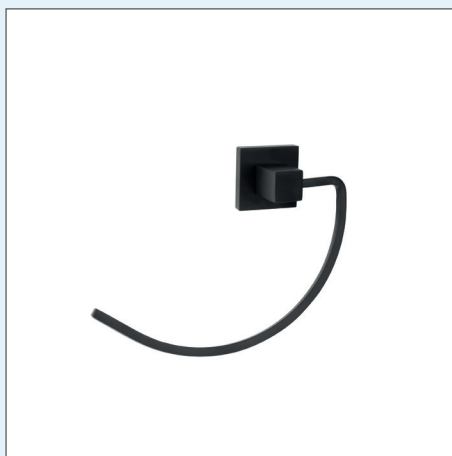

4500 P65 - Toalheiro Argola

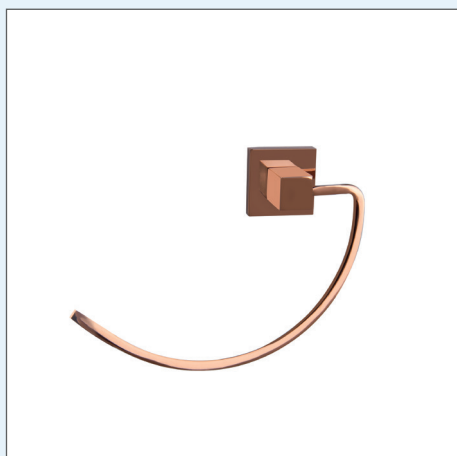

4500 RS65 - Toalheiro Argola



4900 C65 - Toalheiro Barra Duplo 50cm



4900 P65 - Toalheiro Barra Duplo 50cm

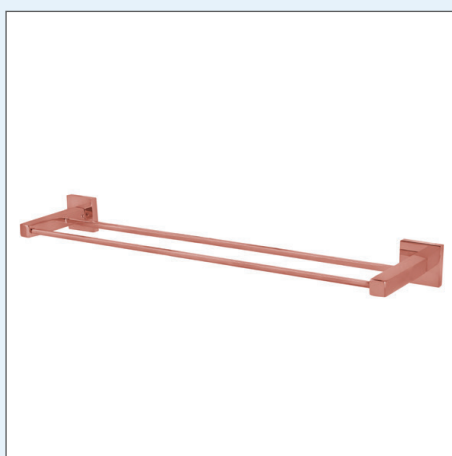

4900 RS65 - Toalheiro Barra Duplo 50cm





Belvedere 65

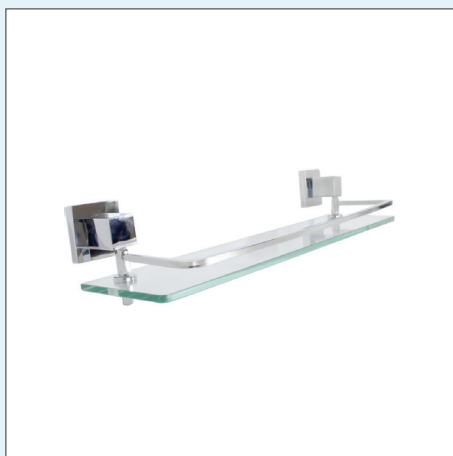

4700 C65 - Prateleira de Vidro - 40 cm



4700 P65 - Prateleira de Vidro - 40 cm

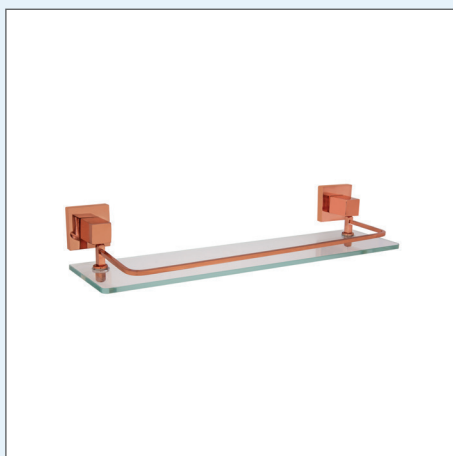

4700 RS65 - Prateleira de Vidro - 40 cm



4400 C65 - Toalheiro Barra Simples - 50 cm

4410 C65 - Toalheiro Barra Simples - 30cm



4400 P65 - Toalheiro Barra Simples - 50 cm

4410 P65 - Toalheiro Barra Simples - 30 cm

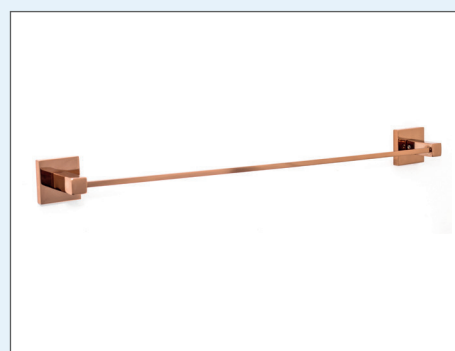

4400 RS65 - Toalheiro Barra Simples - 50 cm

4410 RS65 - Toalheiro Barra Simples - 30 cm





4100 C35 - Saboneteira Parede



4300 C35 - Papeleira s/  
Cobertura



4310 C35 - Papeleira c/  
Cobertura



4500 C35 - Toalheiro Argola



4600 C35 - Cabide Simples



4700 C35 - Prateleira de  
Vidro - 40 cm



4900 C35 - Toalheiro Barra  
Duplo - 50 cm



4400 C35 - Toalheiro Barra  
Simples - 50 cm



## Acessórios

Max C10



4100 C10 - Saboneteira Parede



4610 C10 - Cabide Duplo



4310 C10 - Papeleira c/ Cobertura

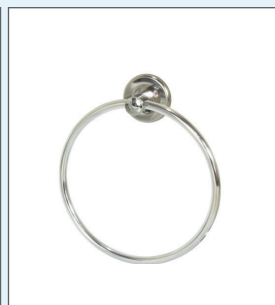

4500 C10 - Toalheiro Argola



4400 C10 - Toalheiro Barra Simples

Master C20

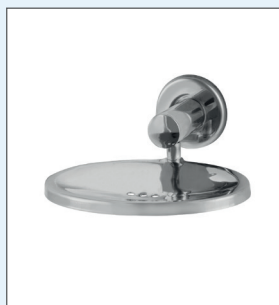

4100 C20 - Saboneteira Parede



4610 C20 - Cabide Duplo



4310 C20 - Papeleira c/ Cobertura

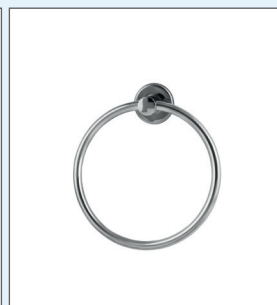

4500 C20 - Toalheiro Argola



4400 C20 - Toalheiro Barra Simples

## Prateleiras

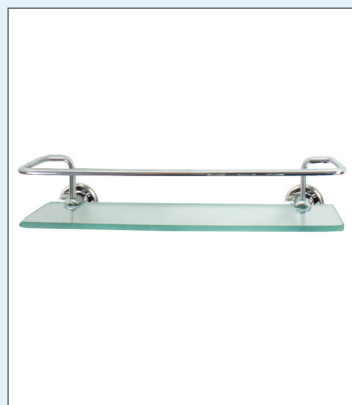

4730 CR - Prateleira Reta Simples 30 cm

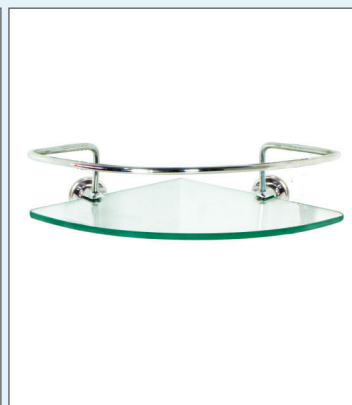

4735 CR - Prateleira Canto Simples - 30cm



4750 CR - Prateleira de Vidro Dupla Reta



4755 CR - Prateleira de Vidro Dupla p/ Canto

## Kits - Acessórios



### KIT 55 - BELVEDERE C65 - 05 PEÇAS

- 4100 C65 - Saboneteira Vidro Parede
- 4300 C65 - Papeleira s/ Cobertura
- 4400 C65 - Toalheiro Barra Simples 50cm
- 4500 C65 - Toalheiro Argola
- 4600 C65 - Cabide Simples



### KIT 55 - SAVASSI C35 - 05 PEÇAS

- 4100 C35 - Saboneteira Parede
- 4300 C35 - Papeleira c/ Cobertura
- 4400 C35 - Toalheiro Barra Simples
- 4500 C35 - Toalheiro Argola
- 4600 C35 - Cabide



### KIT 55 - MASTER C20 - 05 PEÇAS

- 4100 C20 - Saboneteira Parede
- 4310 C20 - Papeleira c/ Cobertura
- 4400 C20 - Toalheiro Barra Simples
- 4500 C20 - Toalheiro Argola
- 4600 C20 - Cabide



### KIT 55 - MAX C10 - 05 PEÇAS

- 4100 C10 - Saboneteira Parede
- 4310 C10 - Papeleira c/ Cobertura
- 4400 C10 - Toalheiro Barra Simples
- 4500 C10 - Toalheiro Argola
- 4600 C10 - Cabide



MVS+

## Uso Geral



1131 CR - Torneira Jardim  
3/4 x 3/4" c/ Guiador



1130 CR - Torneira Jardim  
3/4 x 3/4" c/ Bico



1130 CR - Torneira Jardim  
1/2 x 1/2" c/ Bico



1126 CR - Torneira Jardim  
1/2" s/ Bico



1130 AM - Torneira Jardim  
3/4 x 3/4" c/ Bico



1130 AM - Torneira Jardim  
1/2 x 1/2" c/ Bico



1126 AM - Torneira Jardim  
1/2" s/ Bico

ESFERA

## Esfera



1120 CR - Torneira Esfera  
1/2 x 3/4" Jardim c/ Bico  
1120 CR - Torneira Esfera  
3/4 x 3/4" Jardim c/ Bico



1121 CR - Torn. Esfera Jardim  
1/2 x 3/4" c/ Bico - p/ Cadeado  
1121 CR - Torn. Esfera Jardim  
3/4 x 3/4" c/ Bico - p/ Cadeado



1122 CR - Torn. Esfera c/ Saída  
1/2 x 3/4 x 3/4" p/ Máquina de Lavar



1123 CR - Válvula Esfera p/  
1/2 x 3/4" Máquina de Lavar



## Ligações Flexíveis e Fixações



1940 - Ligação Flexível  
1/2 x 1/2" Trançada c/  
30cm / 40cm /  
60cm



1950 - Ligação Flexível  
1/2 x 1/2" em PVC c/  
30cm / 40cm /  
60cm

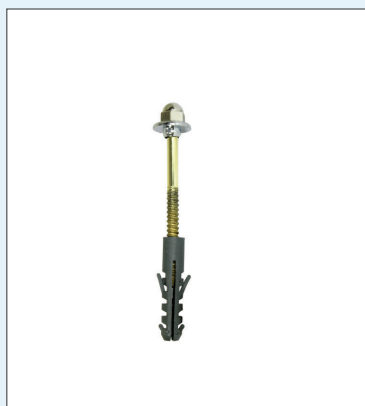

160 I CR - Parafuso de Fixação  
em Inox Bucha nº08  
170 I CR - Parafuso de Fixação  
em Inox Bucha nº10  
172 I CR - Parafuso de Fixação  
em Inox Bucha nº12

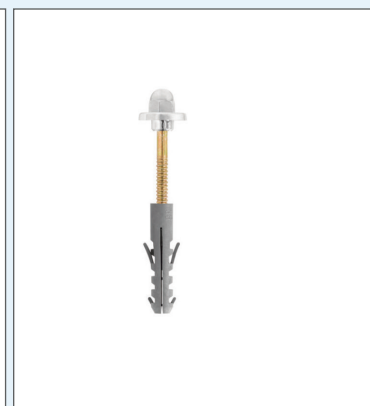

120 F CR - Parafuso de Fixação  
Latonada Bucha nº08  
130 F CR - Parafuso de Fixação  
Latonada Bucha nº10  
132 F CR - Parafuso de Fixação  
Latonada Bucha nº12

## Sifões



1680 CR - Sifão Ajustável p/  
1x 1.1/2" Lavatório c/ 30cm  
1680 CR - Sifão Ajustável p/  
1.1/2 x 1.1/2" Cozinha c/ 30cm  
1680 CR - Sifão Ajustável p/  
1.1/4 x 1.1/2" Tanque c/ 30cm  
1680 CR - Sifão Ajustável p/  
1.1/2 x 2" Cozinha c/ 30cm



2691 CR - Sifão Plást. Ajustável  
1-1.1/4-1.1/2" c/ Copo Universal



2690 CR - Sifão Plást. Ajust.  
1-1.1/4-1.1/2" Universal



2692 CR - Sifão Plást. Ajust.  
1-1.1/4-1.1/2" Duplo



2691 BR - Sifão Plást. Ajust.  
1-1.1/4-1.1/2" c/ Copo Universal



2690 BR - Sifão Plást. Ajust.  
1-1.1/4-1.1/2" Universal



## Tubos de Ligação



1968 CR - Tubo de Ligação  
1.1/2" Ajustável 25cm



1967 CR - Tubo de Ligação  
1.1/2" 25cm



2968 CR - Tubo de Ligação  
1.1/2" Sanfonado em ABS

## Barras de Apoio

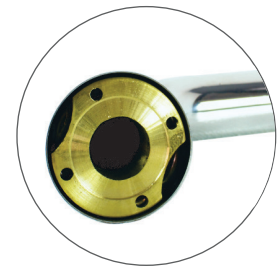
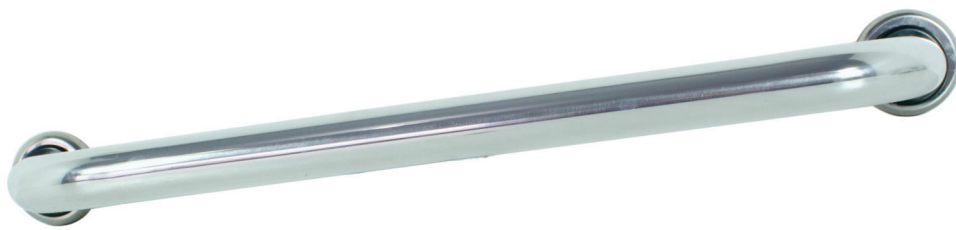

600 CR - Barra de Apoio / 30cm - 40cm - 50cm  
60cm - 70cm - 80cm - 100cm

Fixação Totalmente em Metal e  
Reforçada Com Quatro Parafusos!

## Válvulas



1603 CR - Válvula Click  
1" Lavat. c/ Acab.  
Quadrado



1603 PT - Válvula Click  
1" Lavat. c/ Acab.  
Quadrado



1604 CR - Válvula Lavat.  
1" c/ Tampa e  
Acab. Quadrado



1604 PT - Válvula Lavat.  
1" c/ Tampa e  
Acab. Quadrado



1609 CR - Válvula Lavat.  
1" c/ Tampa click  
Quadrada

# Válvulas



1609 PT - Válvula Lavat.  
1" c/ Tampa click  
Quadrada



1607 CR - Válvula Click  
1" Lavat. Tampa  
Interna Metal

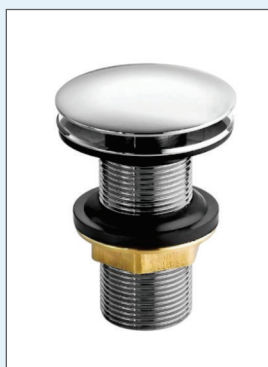

1608 CR - Válvula Click  
1" Lavat. Tampa  
Externa Metal

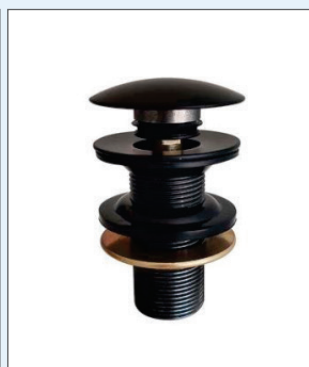

1608 PT - Válvula Click  
1" Lavat. Tampa  
Externa Metal



1605 CR - Válvula Lavatório  
1" Metal s/ Ladrão  
1606 CR - Válvula Lavat.  
1" Metal Rosca  
Longa 100mm



1600 CR - Válvula Lavatório  
1" Inox Curta



2605 - Válvula Lavat.  
1" Abs  
Cores:  CR  P  BR



1611 CR - Válvula Click  
1.1/4" Tanque Tampa  
Interna Metal



1612 CR - Válvula Click  
1.1/4" Tanque Tampa  
Externa Metal



1610 CR - Válvula Tanque  
1.1/4" Metal  
1613 CR - Válvula Tanque  
1.1/4" Metal Rosca  
Longa 90mm



1626 CR - Válvula Americana  
4.1/2" Inox - Cesto Metal



1625 CR - Válvula Americana  
1.1/2" Inox - Cesto Metal



1623 CR - Válvula Americana  
1.1/2" Cesto Abs



2623 CR - Válvula Americana  
1.1/2" Abs  
Cores:  CR  P  BR

## Grelhas / Ralos



1103 CR - Grelha Quadrada c/  
10x10cm Caixilho - Inox 304  
1105 CR - Grelha Quadrada s/  
10x10cm Caixilho - Inox 304  
1003 CR - Grelha Quadrada c/  
10x10cm Caixilho - Inox 430  
1005 CR - Grelha Quadrada s/  
10x10cm Caixilho - Inox 430



1101 CR - Grelha Quadrada c/  
15x15cm Caixilho - Inox 304  
1107 CR - Grelha Quadrada s/  
15x15cm Caixilho - Inox 304  
1001 CR - Grelha Quadrada c/  
15x15cm Caixilho - Inox 430  
1007 CR - Grelha Quadrada s/  
15x15cm Caixilho - Inox 430



1104 CR - Grelha Redonda c/  
10x10cm Caixilho - Inox 304  
1106 CR - Grelha Redonda s/  
10x10cm Caixilho - Inox 304  
1004 CR - Grelha Redonda c/  
10x10cm Caixilho - Inox 430  
1006 CR - Grelha Redonda s/  
10x10cm Caixilho - Inox 430



1102 CR - Grelha Redonda c/  
15x15cm Caixilho - Inox 304  
1109 CR - Grelha Redonda s/  
15x15cm Caixilho - Inox 304  
1002 CR - Grelha Redonda c/  
15x15cm Caixilho - Inox 430  
1009 CR - Grelha Redonda s/  
15x15cm Caixilho - Inox 430

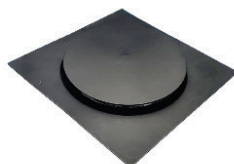

1013 PT - Ralo Click Quadrado  
10x10cm  
1017 PT - Ralo Click Quadrado  
15x15cm



1013 CR - Ralo Click Quadrado  
10x10cm  
1017 CR - Ralo Click Quadrado  
15x15cm



## Bases e Registros



141 AM - Base p/ Registro de  
1/2 ou 3/4" Pressão 1/4 de Volta



140 AM - Base p/ Registro de  
1/2 ou 3/4" Pressão MVS+



150 AM - Base p/ Reg. Gaveta

Bitolas Disponíveis:

1/2"	3/4"	1"	1.1/4"	1.1/2"
------	------	----	--------	--------



1400 AM - Registro de  
1/2 ou 3/4" Pressão MVS+





## Bases e Registros



1509 BT - Reg. de Gaveta Bruto

Bitolas Disponíveis:

1/2"	3/4"	1"	1.1/4"	1.1/2"
------	------	----	--------	--------



805 BR - Base p/ Misturador  
1/2 ou 3/4" de Ducha Higiênica MVS

806 BR - Base p/ Misturador  
1/2 ou 3/4" de Ducha Hig. 1/4 de Volta

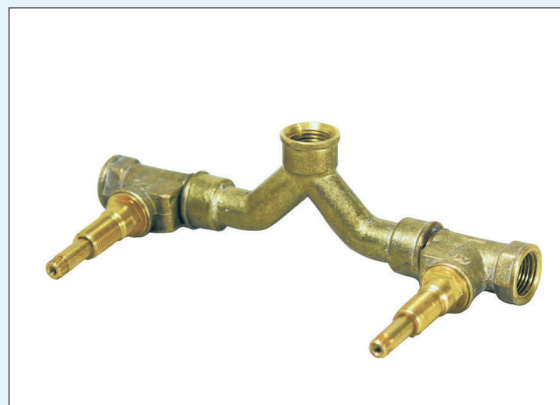

807 BR - Base p/ Misturador  
1/2 ou 3/4" de Chuveiro MVS

808 BR - Base p/ Misturador  
1/2 ou 3/4" de Chuveiro 1/4 de Volta



## Complementos



3207 CR - Prolongador  
1/2 x 1/2" Curto c/ 03cm

3208 CR - Prolongador  
1/2 x 1/2" Médio c/ 05cm

3209 CR - Prolongador  
1/2 x 1/2" Longo c/ 06cm



506 AM - Conversor p/  
Registro Docol

507 AM - Conversor p/  
Registro Fabrimar

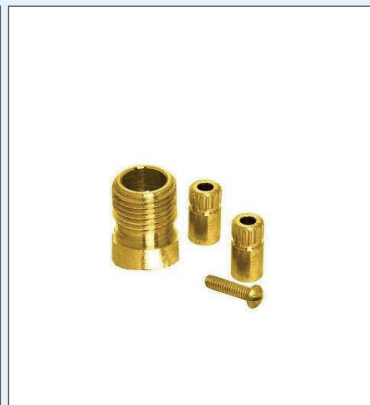

504 AM - Prolongador p/ Reg.  
( Estria e Rosca )



505 BR - Salva Registro em  
Latão - S.O.S

# Componentes

## Filtros e Demais Aplicações

	<p>Produto Certificado</p> 			
<p>1018 CR - Copo de Filtro em 1/4\" Metal com Vela</p>	<p>1008 CR - Copo de Filtro em 1/4\" Abs com Vela</p>	<p>1802 - Vela em Abs p/ Copo de Filtro</p>	<p>1803 - Vela em Abs Blindada p/ Copo de Filtro</p>	<p>1809 CC40/CC50 1/2 x 1/2\" - Junção p/ Filtro Parede c/ Registro</p>
				
<p>1805 CR - Derivação Mesa c/ 1/2x1/2x1/4\" Saída p/ Filtro ou Purificador</p>	<p>1806 CR - Derivação Parede 1/2x1/2x1/4\" c/ Saída p/ Filtro ou Purificador</p>	<p>1147 - Registro p/ Filtro c/ 1/2 x 1/4\" Acabamento Acab. Disponíveis C34/C31/C50/CC40/C44/C23</p>	<p>1804 CR - Junção p/ Filtro 1/2 x 1/2\" Parede em Y</p>	

## Gatilhos e Demais Aplicações

			
<p>986 CR - Ducha Manual 1/4\" Quadrada em Abs s/ Suporte</p>	<p>985 CR - Ducha Manual Luxo 1/2\" em Abs s/ Suporte</p>	<p>984 CR - Ducha Manual em 1/2\" Metal s/ Suporte</p>	<p>745 CR - Flexível p/ ducha 1/2 x 1/2\" Higiênica em Metal 1,20cm</p>

# Componentes

				
1807 CR - Derivação Tee 1/2 x 1/2" p/ Ducha Higiênica	742 CR - Suporte p/ Gatilho da Ducha Higiênica	122 CR - Cabeça p/ Tubo Gourmet	123 CR - Cabeça p/ Tubo Gourmet Cônico 1/2"	623 CR - Cesto em Abs p/ Válvula Americana
				
622 CR - Cesto em Metal p/ Válvula Americana	192 BR - Porca Arruela em Metal 1/2"	193 BR - Porca Arruela em Acetal 1/2"	400 CC40 - Botão de Plástico c/ Trava	402 C50 - Botão de Plástico c/ Rosca

## Gatilhos e Demais Aplicações

			
84 C23 - Cruzeta em Latão 83 C23 - Cruzeta em Abs	84 C44 - Cruzeta em Latão 83 C44 - Cruzeta em Abs	84 C31 - Cruzeta em Latão	84 C34 - Volante em Latão

# Componentes

## Volantes e Mecanismo

				
84 C35 - Volante em Latão	84 CC40 - Volante em Latão 83 CC40 - Volante em Abs	84 C50 - Volante em Latão 83 C50 - Volante em Abs	84 C65 - Volante em Latão	84 C29 - Volante em Latão
				
100 - Vedante Base 1/2" Metal	601 C44 - Castelo Montado MVS	601 C23 - Castelo Montado MVS	615 CR - Mecanismo 1/4 de Volta 610 CR - Mecanismo 1/4 de Volta Invertido	614 CR - Mecanismo MVS
				
613 CR - Castelo Chaveta M18 613 AM - Castelo Chaveta M18	416 CR - Mecanismo p/ Reg. M18 1416 MVS	418 CR - Mecanismo p/ Reg. 1416 Oriente MVS	419 AM - Mecanismo p/ Registro Deca 1/2"	417 CR - Mecanismo p/ Reg. 1416 Oriente MVS



# Componentes



617 CR - Mecanismo 1/4 de Volta Estria Padrão Deca



616 CR - Mecanismo 1/4 de Volta Estria Padrão Docol



612 CR - Mecanismo p/ Torneira Automática

## Canoplas e Reguladores



76 3/4" - Canopla em Abs p/ Reg. 1/2, 3/4 e 1"

CC40 C50 C23 C44



76 3/4" - Canopla em Abs p/ Reg. 1/2, 3/4 e 1"

C31 C34



76 3/4" - Canopla em Metal p/ Reg. 1/2, 3/4 e 1"

C35

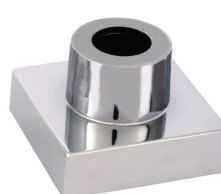

76 3/4" - Canopla em Abs p/ Reg. 1/2, 3/4 e 1"

C65 C29 C61

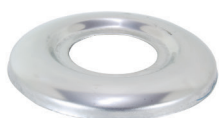

28 CR - Canopla Comum 1/2" c/ Rebaixo



27 CR - Canopla Retra 1/2" Luxo



26 CR - Canopla Quadrada Luxo Abs



500 CR - Regulador de Canopla CR  
500 BR - Regulador de Canopla BR



25 CR - Canopla Para Mecanismo 1/4 de volta M18



## Conexões CR

### Cotovelos



**112 CR - Cotovelo 90°**  
BITOLAS: 1/2 ou 3/4"



**111 CR - Cotovelo Redução 90°**  
3/4 x 1/2"



**113 CR - Cotovelo Macho / Fêmea 90°**  
BITOLAS: 1/2 ou 3/4"

### Tees



**116 CR - Ligação Tee 90°**  
BITOLAS: 1/2 ou 3/4"



**115 CR - Tee Redução 90°**  
3/4 x 1/2"

### Luvas



**106 CR - Luva de Redução**  
BITOLAS: 1/2 ou 3/4"



**101 CR - Luva**  
BITOLAS: 1/2 ou 3/4"

### Níples



**127 CR - Níple**  
BITOLAS: 1/2 ou 3/4"



**125 CR - Níple Redução**  
1/2 x 3/4"

### Buchas



**130 CR - Bucha de Redução**  
3/4 x 1/2"



**131 CR - Bucha de Redução Invertida**  
1/2 x 3/4"

# Conexões LT



## Cotovelos



**111 LT - Cot. Redução 90°**  
3/4 x 1/2"



**113 LT - Cotovelo Macho / Fêmea 90°**  
BITOLAS: 1/2 ou 3/4"



**112 LT - Cotovelo 90°**  
BITOLAS:  
1/2 - 3/4 - 1 - 1.1/4 - 1.1/2 - 2 - 2. 1/2"



**114 LT - Cotovelo 45°**  
BITOLAS:  
1/2 - 3/4 - 1 - 1.1/4 - 1.1/2 e 2"

## Tees e Prolongadores



**116 LT - Ligação Tee 90°**  
BITOLAS:  
1/2 - 3/4 - 1 - 1.1/4 - 1.1/2 - 2 - 2. 1/2"



**115 LT - Tee Redução 90°**  
3/4 x 1/2"



**129LT - Prolongador Macho / Fêmea**

DESCRIÇÃO	BITOLA	COMPRIMENTO ROSCA
Curto	1/2"	18
Médio	1/2"	22
Longo	1/2"	28

## Complementos



**67 LT- Tubete NBR8194**  
BITOLAS:  
1/2 - 3/4 - 1 - 1.1/2"



**60 LT - Porca Virola NBR8194**  
BITOLAS:  
1/2 - 3/4 - 1 - 1.1/2"



**291 LT - Plug Latão**  
BITOLAS:  
1/2 - 3/4 - 1"



**121 LT - Cap Latão**  
BITOLAS:  
1/2 - 3/4 - 1"



# Conexões LT

## Luvas



**106 LT - Luva de Redução**  
3/4 x 1/2"



**101 LT - Luva**  
BITOLAS:  
1/2 - 3/4 - 1 - 1.1/4 - 1.1/2 - 2 - 2. 1/2"

## Buchas



**131 LT - Bucha de Redução**  
1/2 x 3/4" Invertida



3/4 X 1/2"
1 X 1/2"
1 X 3/4"
1 1/4 X 3/4"
1 1/4 X 1"
1 1/2 X 3/4"
1 1/2 X 1 1/4"
2 X 1 1/2"

**130 LT - Bucha de Redução**

## Nipples



**127 LT - Niple**  
BITOLAS:  
1/2 - 3/4 - 1 - 1.1/4 - 1.1/2 - 2 - 2. 1/2"



**125 LT - Niple Redução**  
3/4 x 1/2"



**128 LT - Niple Liso Curto**  
1/2" ou Médio

## Unhões



**109 LT - União Assento Plano**  
BITOLAS:  
1/2 - 3/4 - 1 - 1.1/4 - 1.1/2 - 2 - 2. 1/2"

## Registros



**1450 M/F - Registro Esfera**  
1/2"



**1450 M/F - Registro Esfera**  
3/4"



# Cavaletes



Simple



Obs: Imagem meramente ilustrativa. Para saber mais detalhes de todos os componentes que acompanham o kit cavalete, consulte a tabela abaixo, um representante autorizado MK ou nossa central de vendas

DESCRIÇÃO	BITOLA
Kit Copasa Passeio Pontas 60/75	1/2"
Kit Copasa Passeio Pontas 60/75	3/4"
Kit Copasa Passeio Completo S/ Pontas	1"
Kit Copasa Passeio Completo S/ Pontas	1 1/2"
Kit Copasa Passeio Completo C/ Pontas 70/70 cm	1"
Kit Copasa Passeio Completo C/ Pontas 70/70 cm	1 1/2"
Kit Copasa Muro Completo C/ Pontas 100 / 100 cm	1/2"
Kit Copasa Muro Completo C/ Pontas 100 / 100 cm	1"
Kit Copasa Muro Completo C/ Pontas 100 / 100 cm	1 1/2"
Kit Copasa Antigo C/ Pontas 45/50 cm	1/2"
Kit Copasa Fluxo Invertido C/ Pontas 50/50 cm	1/2"
Kit Copasa Pontas 60/60 cm C/ Hidrômetro	

Múltiplo



Obs: Imagem meramente ilustrativa. Para saber mais detalhes de todos os componentes que acompanham o kit cavalete, consulte a tabela abaixo, um representante autorizado MK ou nossa central de vendas

DESCRIÇÃO	BITOLA
Kit Múltiplo Copasa Com 02 Entradas	1/2"
Kit Múltiplo Copasa Com 02 Entradas	3/4"
Kit Múltiplo Copasa Com 03 Entradas	1/2"
Kit Múltiplo Copasa Com 03 Entradas	3/4"
Kit Múltiplo Copasa Com 04 Entradas	1/2"
Kit Múltiplo Copasa Com 04 Entradas	3/4"
Também Temos a Opção de Kits Montados, consulte Tabela de Vendas	

# Hidrômetro

CAVALETES MK  
PRODUTOS APROVADOS



Hidrômetro para aplicações residenciais e industriais de medição de consumo de água conforme a norma ABNT NBR 16043 e portaria INMETRO N° 155/2022, com registro de água diretamente na relojoaria que possui ângulo de 45° facilitando a leitura e mantendo a classe de exatidão.



710 - 1/2" ou 3/4" - Hidrômetro Unijato P/ Medição Interna e Individualização de Abastecimento.

*"Elegância e qualidade ao alcance de suas mãos..."*



Fique por dentro do  
que acontece na MK Metais.



Baixar Nosso  
Catálogo



Novidades e  
Atualizações



31 3419 - 6400  
vendas@mkmetais.com.br  
Produzido em Minas Gerais



[mkmetais.com.br](http://mkmetais.com.br)



\*Consulte condições de aplicação de garantia do produto.

MAFAL METAIS SANITÁRIOS LTDA - EPP  
Rua Dona Alexandrina - 66 - Bairro Pedro II  
Belo Horizonte - MG / CEP 31230 - 030  
CNPJ 08.630.573/0001-00

Catálogo de Produtos - versão 23/24

A Mafal Metais Sanitários é detentora da Marca MK Metais Sanitários e Conexões. Imagens meramente ilustrativas. A MK Metais Sanitários e Conexões reserva-se ao direito de modificar, alterar ou excluir qualquer item deste catálogo sem aviso prévio. É expressamente proibida a cópia ( impressa ou digital ) de partes ou na totalidades deste catálogo sem prévia autorização.